

Fast Charge Deep Cycle Lead Carbon Battery

HLC12-200

HLC series lead-carbon batteries use functional activated carbon and graphene as carbon materials, which are added to the negative plate of the battery to make lead carbon batteries have the advantages of both lead-acid batteries and super capacitors. It not only improves the ability of rapid charge and discharge, but also greatly prolongs the battery life. It is more suitable for the application of PSOC.

12V
200Ah

Lead Carbon
Technology

Deep
Cycle



COMPLIED STANDARDS

IEC 60869-21-22 JIS C8704 YD/T799
BS6290 part4 GB/T 19638 UL 1989



General Features

- ✓ Combine the characteristics of lead acid battery and super capacitor
- ✓ Long life cycle service design, excellent PSOC and cyclic performance
- ✓ High power, rapid charging and discharging
- ✓ Unique grid and lead pasting design
- ✓ Extreme temperature tolerance
- ✓ Able to operate at -30°C -60°C
- ✓ Deep Discharge recovery capability

Applications

- Home Energy storage system
- Smart Power grid system
- Solar & Wind Power system
- Wheel chair, Golf Car
- Telecom systems
- BTS Stations
- Micro-grid system

Technical Specifications

Nominal Voltage		12V(6 cells per unit)
Design Floating Life @25°C		20 Years
Nominal Capacity @25°C(20 hour rate@10.00A,10.50V)		200.0Ah
Capacity @25°C	10 hour rate (18.56A,10.8V)	185.6Ah
	5 hour rate (34.40A,10.5V)	172.0Ah
	1 hour rate (120.3A,9.60V)	120.3Ah
Internal Resistance	Full Charged Battery@25°C	≤3.4mΩ
Ambient Temperature	Discharge	-30°C~60°C
	Charge	-30°C~60°C
	Storage	-30°C~60°C
Max. Discharge Current@25°C		2000A(5s)
Capacity affected by Temperature (10 hr Capacity)	40°C	108%
	25°C	100%
	0°C	90%
	-15°C	70%
Self-Discharge@25°C per Month		3%
Charge (Constant Voltage) @25°C	Standby Use	Initial Charging Current Less than 50.0A Voltage 13.6-13.8V
	Cycle Use	Initial Charging Current Less than 50.0A Voltage 14.4-14.7V

Dimensions & Weight

Length(mm)	522±1
Width(mm)	240±1
Height(mm)	219±1
Total Height(mm)	223±1
Weight(kg)	64.8±3%

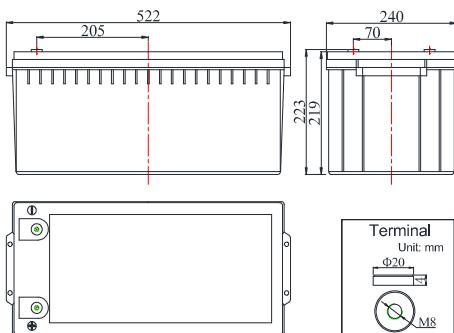

Battery Discharge Table

Discharge Constant Current per Cell(Ampers at 25 °C)

F.V/Time	5min	10min	15min	20min	25min	30min	35min	40min	45min	60min	90min	2h	3h	4h	5h	6h	7h	8h	10h	12h	20h
1.60V	543.8	346.8	294.6	239.9	211.5	188.4	166.3	151.1	138.2	120.3	97.2	76.4	53.7	43.9	36.4	30.5	26.8	24.0	20.38	17.14	10.60
1.65V	534.0	340.4	289.3	236.0	207.8	184.9	163.2	148.3	135.7	117.9	95.2	74.9	52.6	43.1	35.7	29.9	26.4	23.6	19.99	16.83	10.40
1.67V	528.7	337.2	286.1	232.2	206.0	183.3	162.3	147.6	135.0	116.9	94.6	74.2	52.2	42.6	35.3	29.6	26.2	23.4	19.79	16.71	10.30
1.70V	518.0	331.0	280.6	228.1	202.1	179.7	159.6	145.1	132.8	114.5	92.6	73.6	51.7	42.2	35.1	29.4	26.0	23.2	19.38	16.42	10.22
1.75V	514.1	327.5	278.6	225.2	199.0	178.1	157.5	143.2	130.9	113.2	91.8	72.1	50.6	41.5	34.4	29.0	25.5	22.7	19.18	16.16	10.00
1.80V	497.8	317.0	268.9	220.2	193.1	172.4	152.8	139.0	127.0	109.7	88.9	69.2	48.7	39.6	33.1	27.9	24.5	21.9	18.56	15.63	9.70

Discharge Constant Power per Cell(Watts at 25 °C)

F.V/Time	5min	10min	15min	20min	25min	30min	35min	40min	45min	60min	90min	2h	3h	4h	5h	6h	7h	8h	10h	12h	20h
1.60V	1019.0	653.7	555.5	454.6	402.4	359.8	317.7	289.6	265.1	230.9	186.1	146.6	103.0	84.2	69.7	58.4	51.5	46.1	39.0	33.0	20.60
1.65V	1004.4	643.9	548.6	449.1	396.9	354.8	312.0	283.8	261.2	226.8	182.9	144.1	101.3	82.9	68.8	57.3	50.9	45.4	38.4	32.4	20.40
1.67V	997.3	638.6	543.6	444.5	393.7	351.6	310.4	282.9	259.6	224.4	181.6	142.8	100.4	82.0	68.0	57.1	50.4	45.0	38.1	32.2	20.30
1.70V	988.1	629.4	534.9	436.3	386.6	344.7	306.0	278.3	255.7	220.3	177.9	141.5	99.3	81.2	67.5	56.7	50.0	44.6	37.3	31.6	20.20
1.75V	982.8	624.2	531.5	430.5	381.1	341.5	302.1	275.1	251.5	217.9	176.2	138.7	97.4	79.9	66.2	55.8	49.1	43.7	36.9	31.2	19.80
1.80V	954.0	606.8	515.5	422.8	371.0	331.0	293.4	267.6	244.2	211.2	170.7	133.5	93.7	76.2	63.8	53.7	47.0	42.0	35.7	30.2	19.20

Note: The above data are average values, and can be obtained within 3 charge/discharge cycles. These are not minimum values. Cell and battery designs/specifications are subject to modification without notice. Contact **CSPower** for the latest information.

PERFORMANCE CHARACTERISTICS

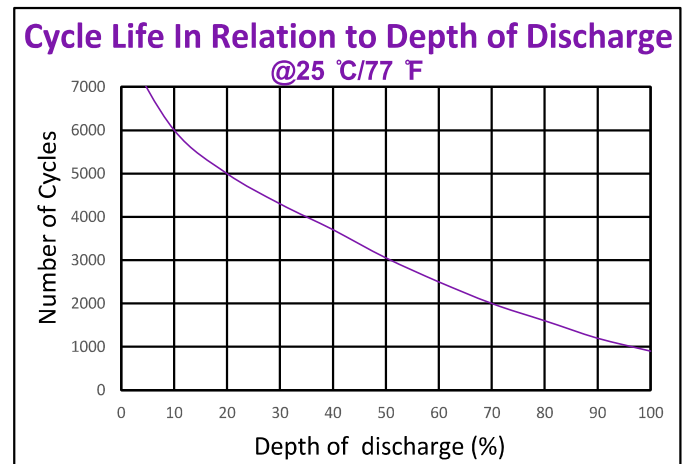
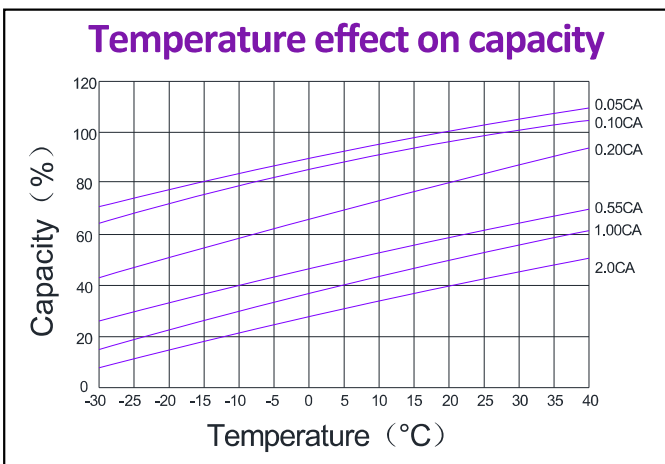
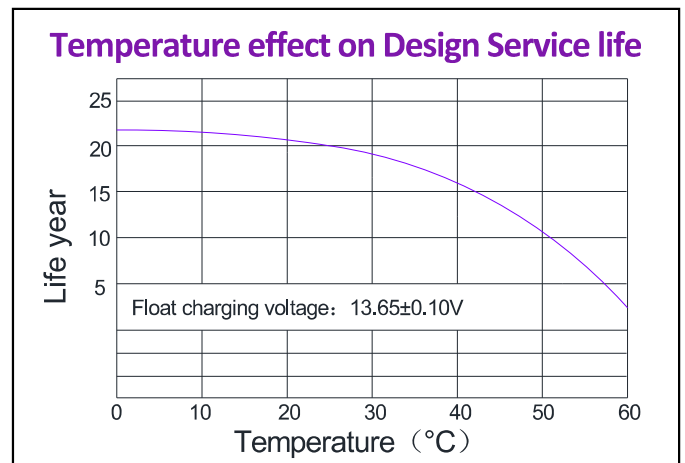
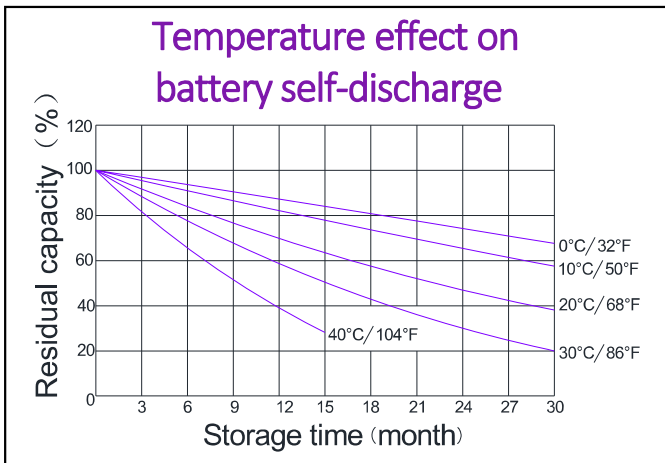
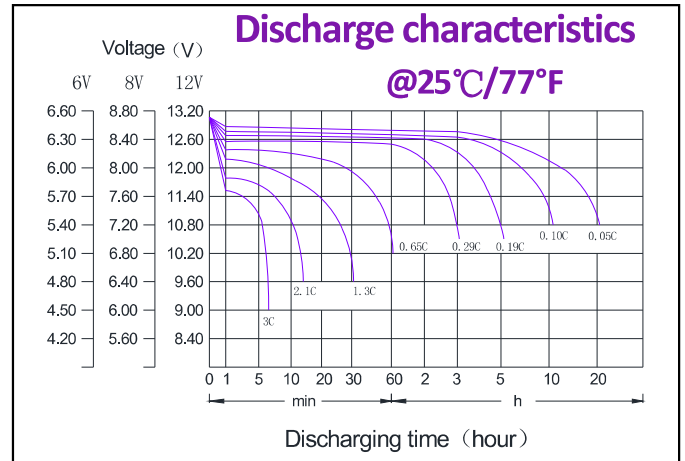
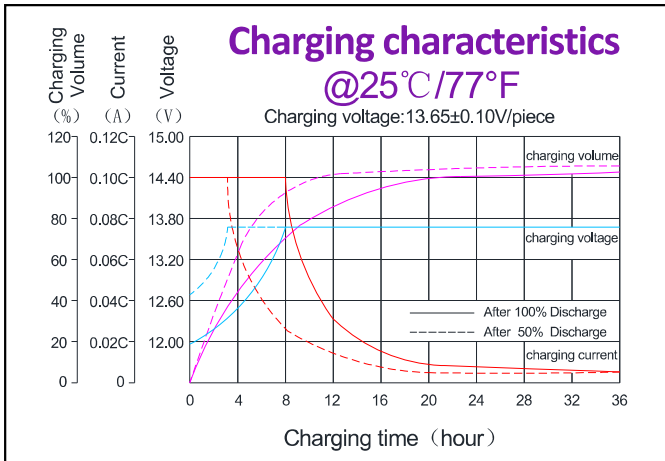

BATTERY CONSTRUCTION

Component	Positive plate	Negative plate	Container & Cover	Safety valve	Terminal	Separator	Electrolyte	Pillar seal
Features	Rare earth alloy grid with good corrosion resistance	Unique anode formula, high purity material, low self-discharge rate	ABS (UL94-V0 optional)	Flame resistance, aging resistance	Female Copper Insert M8 (torque: 10~12N.m)	AGM separator with organic fiber, longer service life	Gradual change gel electrolyte (with patent)	Anti-corrosion elastic O ring, two layers epoxy seal technology

CSPower Battery Tech Co., Ltd.

Add: Floor 3, Evolution Space, NO.61, Liuxian 2nd Road, Baoan, Shenzhen, China

Tel: +86-755-29123661 Email: sales@cspbattery.com



WWW.CSPBATTERY.COM